



DUCTING

CATALOGUE
2023

Full Solution Provider

Power & Telecom
Ducting Specialists

Global Manufacturer
of Power & Telecom
Solutions

Introduction	Page 3
Why Emtelle	Page 4
Benefits of Ducting Power Cables	Page 6
uPVC Power Duct	Page 10
Con-Duct	Page 24
HDD Duct	Page 28
PE Coiled Service Duct	Page 32
uPVC Telecom Duct	Page 34
Multipath	Page 44
HDPE Sub-Duct	Page 48
Accessories	Page 52

Emtelle are a complete solution provider of uPVC duct, accessories and ancillary for a complete end to end duct solution from a single reputable source.

With capacity to supply underground power solutions for the Distribution and Transmission networks within the power sector. Emtelle continuously support the ever-expanding power network.

We offer on-site certified training and continuous technical support to our customers to ensure you are supported every step of the way.

We are continuously expanding our range and are now offering High Strength uPVC products and a wider selection using our recycled material.

On the following pages you will find out more on why Emtelle are the supplier of choice, and how the Emtelle product solution library enhances global ducting roll-outs.



Our Factories

Emtelle operates in the UK, Germany, Denmark, Dubai and the USA, as well as sales representatives in the Netherlands, Sweden, Eastern Europe & Malaysia. Emtelle serves over 100 countries globally, combining proven knowledge with continuous innovation for the last 40 years.

Established Industry Leader

With over 40 years of experience extruding uPVC, Emtelle is the leading Power and Telecom ducting provider—the first extrusion dating back to the early 1980s from the Jedburgh factory in the Scottish Borders. Emtelle's uPVC range has since expanded with the addition of new extrusion lines, bend machines, and factory expansions, resulting in more space for growth. Emtelle also develops unique socket designs and provides solutions for all power network parts.

Full Solution Provider

Supplying a unique and complete solution to an ever-expanding market is more pertinent now than ever. Emtelle acknowledges the challenges that providers and operators face when combining all the different components within a passive network and ensuring efficient delivery of all at the right time. Emtelle, with its one-stop-shop ethos, is all about providing customers with one direct route



to sourcing a complete end-to-end solution, from uPVC duct to duct bends, from connectors to accessories. It's a way of making our customers' lives easier, enabling them to focus on what is paramount – creating connections effectively and efficiently.

Offering Superior Support

Emtelle offers the full solution in terms of solution supply, customer service, support and training, from initial concept to installation and beyond. Emtelle provides the highest standard of excellence throughout all its activities by using the company's production capacity and technical knowledge to develop, perfect & sustain the optimum solutions; the entire Emtelle offering adds value to Power and Telecom networks around the world.

POWER CABLES IN DUCTING – ADVANTAGES

- Excavation and backfill activities do not interfere with cable supply and installation.
- When trenching, shorter sections can be excavated and backfilled, making it easier to manage.
- Less disruption due to shorter and smaller excavation areas needed at once – site security, traffic management, residential- and agricultural distributions reduced.
- PVC duct gives both physical and mechanical protection from third-party and environmental damage.
- Ducting reduces project time and lowers cost.
- When needed, the full length of cable can be removed and re-installed without digging up the full length of cable.
- PVC duct gives a smooth internal surface to minimise any cable damage.
- Cables can be buried under various conditions with a range of ducted solutions.



DUCTING TIME OF INSTALLATION

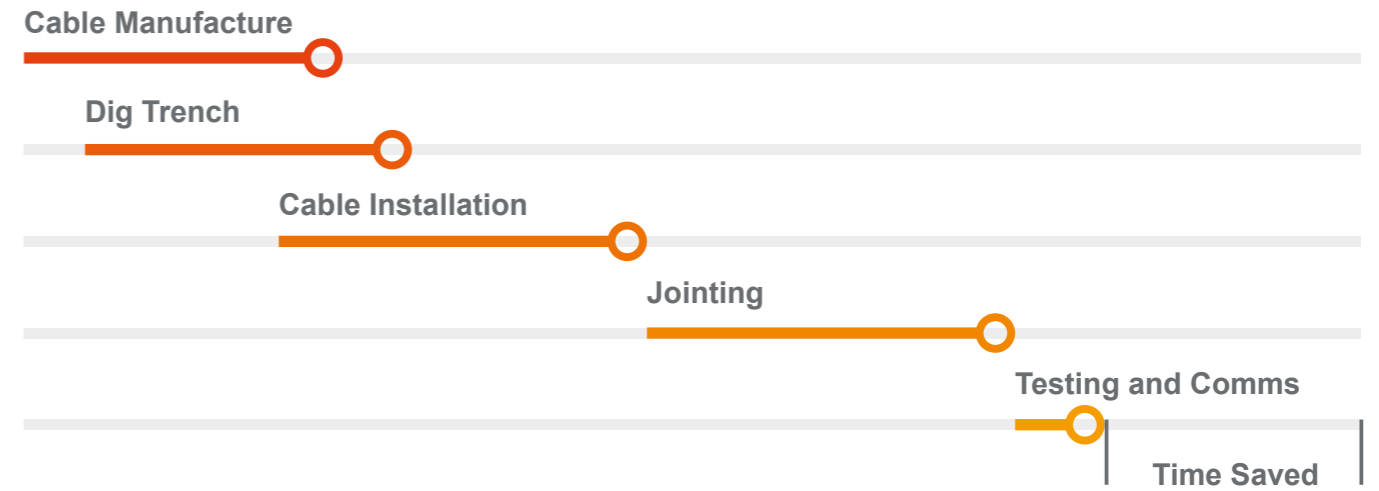

OPEN TRENCH/DIRECT BURIED – DISADVANTAGES

- Additional time and cost waiting for cables to be made before any work commences.
- Additional fencing and security required – added disruptions for longer periods.
- Can increase project time and cost.
- No physical or mechanical protection – higher grade power cable required to protect from cable damage.
- All cables must be installed on day one with a limited scope of upgrading.
- Replacing cables is costly and requires large excavation areas.
- Direct buried cables require longer open trench lengths, increasing environmental risks.

OPEN TRENCH/DIRECT BURIED TIME OF INSTALLATION

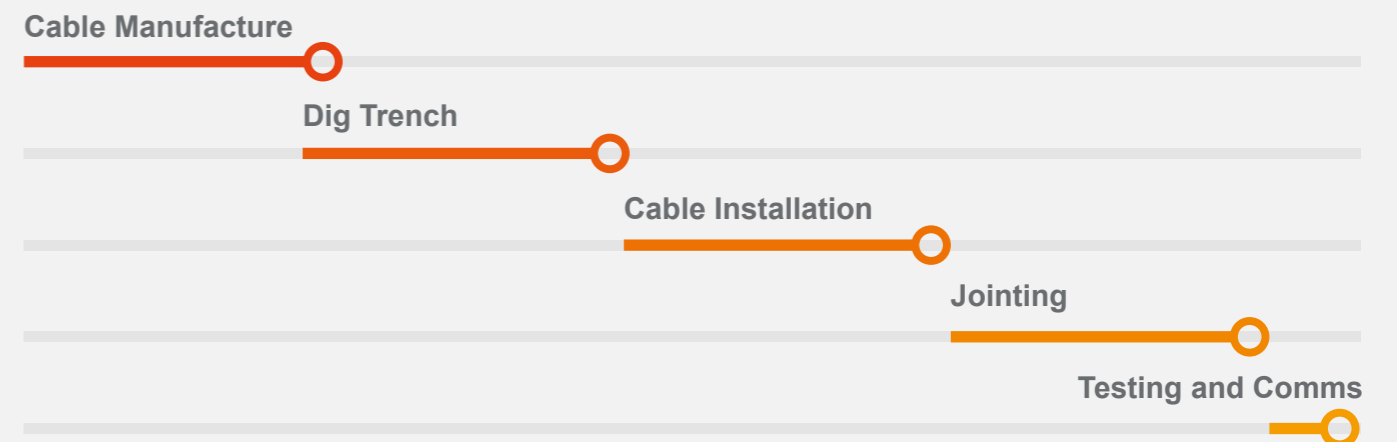

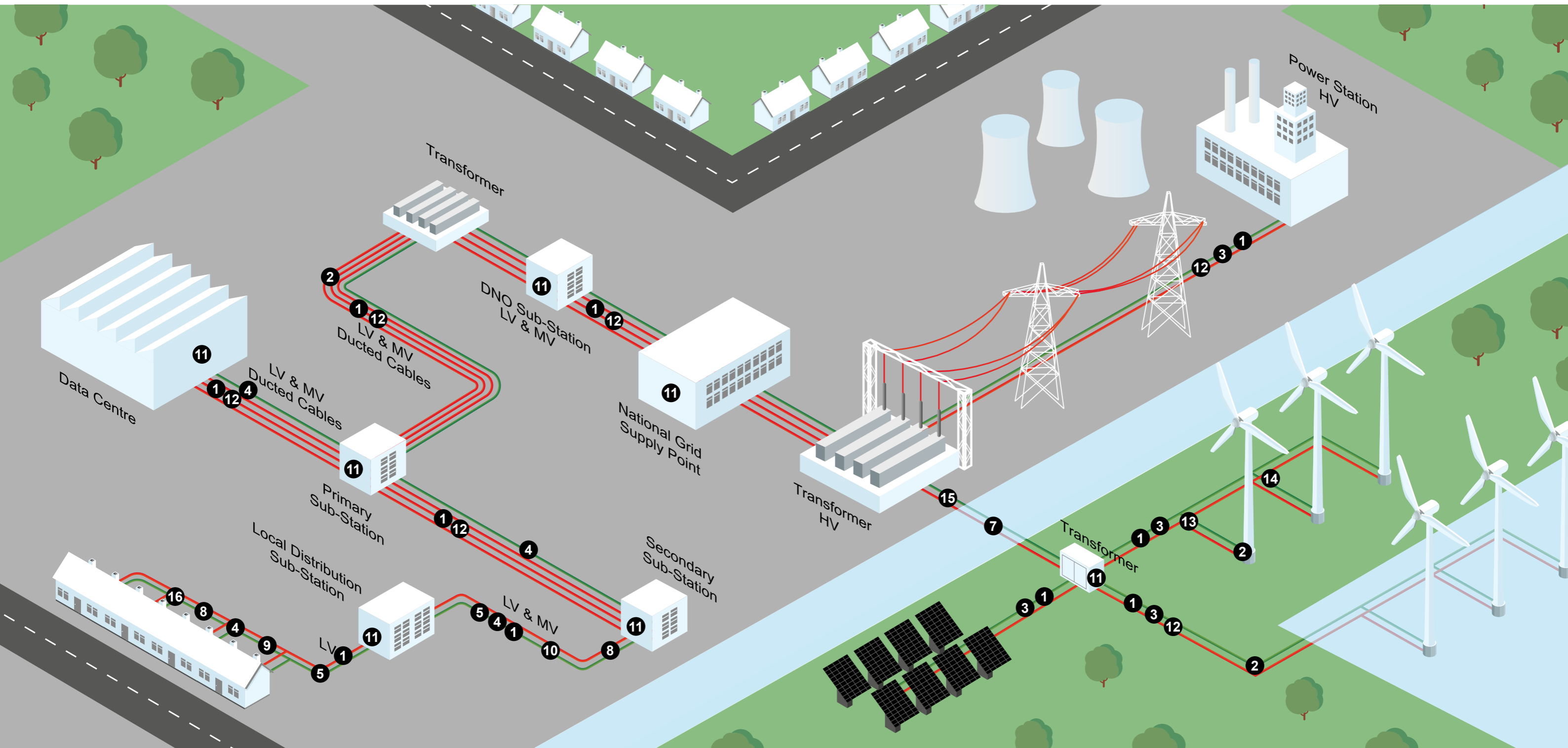

- 1  uPVC Power Duct IRS / IF
- 2  uPVC Bends
- 3  uPVC Conductive Power Duct
- 4  uPVC Telecom Duct
- 5  uPVC Telecom Bends
- 6  Multipath
- 7  HDD Duct
- 8  PE Coiled Service Duct
- 9  Hockey Stick Bends
- 10  Sub-Duct
- 11  Cable Seals
- 12  Cable Protection
- 13  Connector Sleeves
- 14  Ringseal Couplers
- 15  Transition Couplers
- 16  Swept Tee

Emtelle UK has developed a comprehensive range of Power Duct systems and accessories designed to meet performance requirements for underground Power networks. All of our ducts meet industry standards ENATS 12-24.

Emtelle uPVC duct systems for the Power industry consist of a comprehensive range of duct sizes, bends and accessories. These ducts can be supplied with either an Interference Fit Socket (IP4X) or Interference Ring Seal Socket (IP68).



For Power Accessories please see page 54 - 59

IP4X
Rated Socket

Interference
Fit (IF)
Socket

Class 1,
Class 2,
High Strength

IP68
Rated Socket

Interference
Ring Seal (IRS)
Socket

Class 1,
Class 2,
High Strength



FEATURES & BENEFITS

- The ability to withstand compression forces from external loading.
- Ease of installation with integral jointing system, making the product simple to install.
- Due to the unique design of our ducting system, bi-directional cable pulling is possible.
- Enhanced cable performance through efficient heat dissipation offered by uPVC duct systems, due to the high compression to wall thickness ratio, compared with alternate systems.
- Systems are re-useable when cables are replaced or repaired, therefore maximising asset life and reducing further disruptions to the roadways and footways.

OUR SYSTEMS

- Class 1 equals 450N at 75°C, equivalent to 750N at ambient temperatures
- Class 2 equals 450N at 50°C, equivalent to 550N at ambient temperatures
- High Strength equals 1500N at 23°C



MEASURING uPVC DUCT BENDS

Preform bends are measured by their angle and radius. The illustrations below show how these parameters are measured against preformed uPVC bends.

(NOTE the radius is measured from the centreline)

Circumferential Length = Arc Length 1.9m

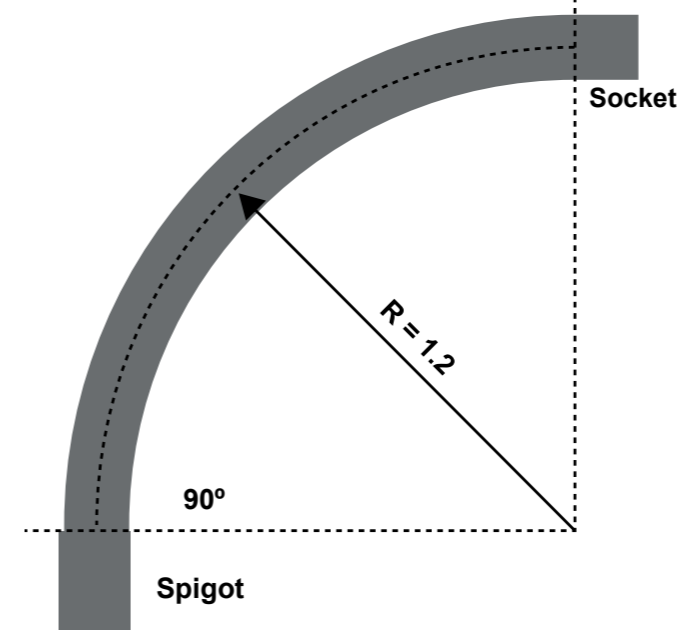

Circumferential Length = Arc Length 0.95m

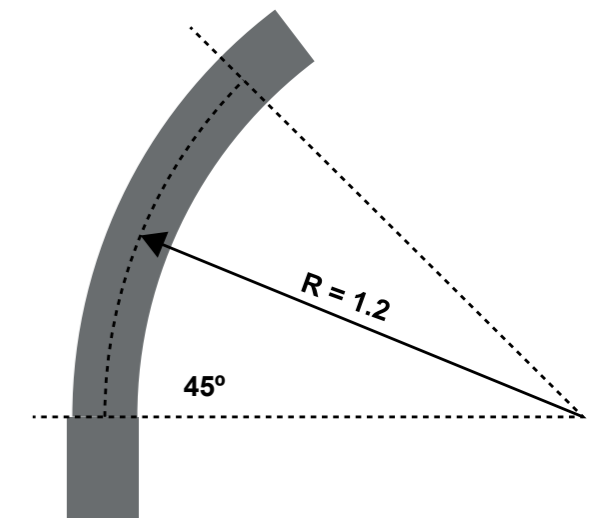

Circumferential Length = Arc Length 1.53m

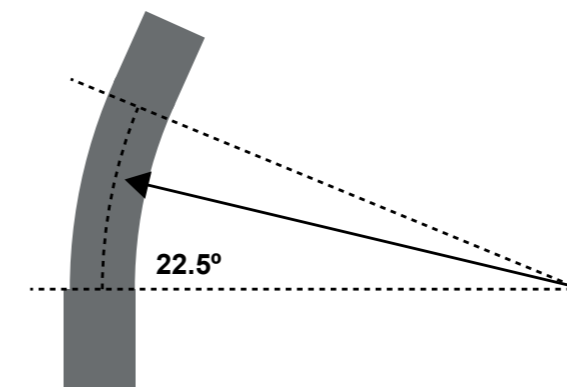

Circumferential Length = Arc Length 0.77m

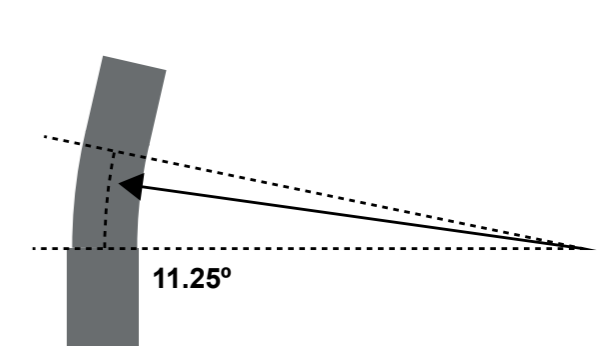



uPVC INTERFERENCE FIT DUCT (IF) IP4X Rated

uPVC INTERFERENCE RING SEAL DUCT (IRS) IP68 Rated

PRODUCT SPECIFICATIONS						
Nominal OD / ID	Class	Length	Red	Black	Packing QTY	
					Meters	Lengths
88.9 / 82 mm	1	6m	✓	5079T	828m	138
88.9 / 83 mm	2	6m	✓	5079	828m	138
96.5 / 89 mm	1	6m	✓	20159	690m	115
96.5 / 90 mm	2	6m	✓	3772S	690m	115
110 / 102 mm	1	6m	5302	3769S	540m	90
110 / 103 mm	2	6m	✓	4748S	540m	90
125 / 117 mm	1	6m	5333NP	5080T	408m	68
125 / 118 mm	2	6m	✓	5080	408m	68
160 / 150 mm	1	6m	5750	3769S	234m	39
160 / 151 mm	2	6m	✓	4749	234m	39
180 / 169 mm	1	6m	✓	20300	168m	28
200 / 188 mm	1	6m	5893	5888	150m	25
225 / 213 mm	1	6m	20405	20305	108m	18
250 / 237 mm	1	6m	✓	20284	96m	16

PRODUCT SPECIFICATIONS						
Nominal OD / ID	Class	Length	Red	Black	Packing QTY	
					Meters	Lengths
110 / 102 mm	1	6m	20423	5331	540m	90
160 / 150 mm	1	6m	20211	5338	234m	39
180 / 169 mm	1	6m	✓	20958	168m	28
200 / 188 mm	1	6m	20339	✓	150m	25
225 / 213 mm	1	6m	✓	21274	108m	18
250 / 237 mm	1	6m	20338	20394	96m	16

✓ available on request

EF450-014
Scan QR code for
Datasheet



✓ available on request



EF450-014
Scan QR code for
Datasheet

uPVC INTERFERENCE FIT BEND (IF) IP4X Rated

Bespoke bends available on request

PRODUCT SPECIFICATIONS					
Nominal OD of Duct	Radius	Angle (deg°)	Red	Black	Packing QTY
88.9mm	1.5m	11.25°	✓	5492	10 items / bag
		22.5°	✓	5118	12 items / bag
110mm	0.45m	90°	20124	5886	15 items / bag
		0.56m	45°	5436	5856
	0.7m	11.25°	✓	5854	20 items / bag
		22.5°	✓	5855	20 items / bag
	1.2m	11.25°	20049	20453	10 items / bag
		22.5°	20050	20396	50 items / timber frame
		45°	20051	20403	50 items / timber frame
		90°	20052	20273	50 items / timber frame
	1.75m	22.5°	20335	3987	10 items / bag
	3.5m	11.25°	20334	3986	10 items / bag
125mm	1.2m	11.25°	4736U	4736B	5 items / bag
		22.5°	4614U	5427	5 items / bag
		45°	4624U	5426	5 items / bag
		90°	4615U	20107	50 items / timber frame
160mm	0.56m	22.5°	5568	✓	5 items / bag
		45°	✓	5860	5 items / bag
		90°	20125	5861	25 items / timber frame
	1.2m	11.25°	5452U	5858	25 items / timber frame
		22.5°	5453U	5859	25 items / timber frame
		45°	5454U	20544	25 items / timber frame
		90°	5455U	20285	25 items / timber frame
		3.9m	11.25°	5482R	5482
	22.5°		5479R	5479	39 items / timber frame

PRODUCT SPECIFICATIONS					
Nominal OD of Duct	Radius	Angle (deg°)	Red	Black	Packing QTY
180mm	3.9m	11.25°	✓	72995	28 items / timber frame
		22.5°	✓	✓	28 items / timber frame
200mm	3.9m	11.25°	5894	20042	25 items / timber frame
		22.5°	5899	5900	25 items / timber frame
225mm	3.9m	11.25°	✓	71663	18 items / timber frame
		22.5°	✓	71664	18 items / timber frame
250mm	3.9m	11.25°	✓	71570	16 items / timber frame
		22.5°	✓	72855	16 items / timber frame

✓ available on request

EF450-012
Scan QR code for
Datasheet



uPVC INTERFERENCE RING SEAL BEND (IRS) IP68 Rated

Bespoke bends available on request

PRODUCT SPECIFICATIONS						
Nominal OD of Duct	Radius	Angle (deg°)	Red	Black	Packing QTY	
110mm	0.45m	90°	20548	20839	10 items / bag	
	0.56m	45°	21078	21193	10 items / bag	
	0.7m	11.25°	✓	21190	21190	20 items / bag
		22.5°	✓	21087	21087	20 items / bag
	1.2m	11.25°	✓	21191	21191	10 items / bag
		22.5°		20520	21198	10 items / bag
		45°		20743	✓	50 items / timber frame
		90°		20540	20676	50 items / timber frame
	1.75m	22.5°	20113	5180	10 items / bag	
	3.5m	11.25°	✓	5336	10 items / bag	
160mm	0.56m	22.5°	21073	21088	5 items / bag	
		45°	20639	73003	5 items / bag	
		90°	20529	73002	25 items / timber frame	
	1.2m	11.25°	20559	21032	25 items / timber frame	
		22.5°	20744	20518	25 items / timber frame	
		45°	20608	20532	25 items / timber frame	
		90°	20528	20513	25 items / timber frame	
	3.9m	11.25°	5493R	5493	39 items / timber frame	
		22.5°	5420R	5420	39 items / timber frame	
180mm	3.9m	11.25°	✓	20962	28 items / timber frame	
		22.5°	✓	21170	28 items / timber frame	

PRODUCT SPECIFICATIONS					
Nominal OD of Duct	Radius	Angle (deg°)	Red	Black	Packing QTY
200mm	3.9m	11.25°	20110	5694	25 items / timber frame
		22.5°	20111	9497	25 items / timber frame
225mm	3.9m	11.25°	✓	21308	18 items / timber frame
		22.5°	✓	21309	18 items / timber frame
250mm	3.9m	11.25°	21028	70612	16 items / timber frame
		22.5°	21029	70613	16 items / timber frame

✓ available on request

EF450-012
Scan QR code for
Datasheet





CONNECTOR SLEEVE IP4X Rated

RING SEAL SLIP COUPLER IP68 Rated

RING SEAL STOP COUPLER IP68 Rated

PRODUCT SPECIFICATIONS

Nominal ID	Length	Connector Sleeve		Packing QTY
		Red	Black	
88.9mm	150mm	21003	5306	75 items / bag
96.5mm	200mm	✓	103S	75 items / bag
110mm	200mm	5236	4044	50 items / bag
125mm	250mm	5570	5621	25 items / bag
160mm	305mm	5235	3748	15 items / bag
180mm	400mm	✓	20311	5 items / bag
200mm	400mm	20503	20312	5 items / bag
225mm	400mm	✓	20313	5 items / bag
250mm	500mm	✓	20772	5 items / bag

✓ available on request



EF450-009
Scan QR code for
Datasheet

PRODUCT SPECIFICATIONS

Nominal ID	Length	Slip Coupler		Stop Coupler		Packing QTY
		Red	Black	Red	Black	
110mm	375mm	20909	20912	20458	20855	20 items / bag
160mm	395mm	20628	20853	20603	20850	10 items / bag
200mm	395mm	20984	20985	20960	20959	5 items / bag
250mm	500mm	21171	21155	21152	21154	3 items / bag

EF450-073
Scan QR code for
Datasheet



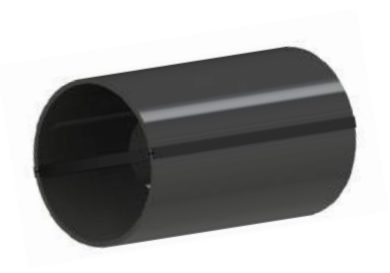

SPLIT DUCT

SPLIT DUCT REPAIR COUPLERS

PRODUCT SPECIFICATIONS					
Nominal OD	Length	Red	Black	Packing QTY	
				Meters	Lengths
110mm	3m	71893	71799	270m	90
125mm	3m	71894	✓	204m	68
160mm	3m	71896	71794	117m	39
200mm	3m	71897	71801	75m	25
225mm	3m	71934	71877	54m	18
250mm	3m	✓	71935	48m	16

PRODUCT SPECIFICATIONS					
Nominal ID	Length	Red	Black	Packing QTY	
				Meters	Lengths
110mm	200mm	71898	✓	204m	68
125mm	250mm	71899	✓	117m	39
160mm	300mm	71901	71780	75m	25
200mm	400mm	71903	71902	54m	18
225mm	450mm	71938	71937	48m	16
250mm	500mm	✓	71939		

✓ available on request

✓ available on request



EF450-020
Scan QR code for
Datasheet



EF450-020
Scan QR code for
Datasheet

Emtelle Con-Duct range of ducted products enables rapid tractability of cable sheath faults within a ducted network, due to our innovative conductive coating.

Our ring seal and push fit conductive ducted systems are suitable for use on UK National Grid and SSE Transmission projects.

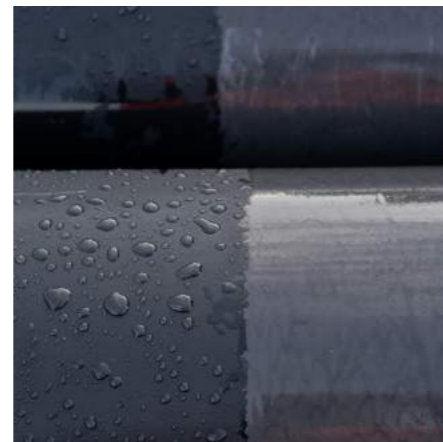

Depth of Entry Mark

Conductive Coating

Interference Fit (IF) Socket

IP4X Rated Socket

Class 1

Interference Ring Seal (IRS) Socket

IP68 Rated Socket

Class 1



uPVC INTERFERENCE FIT CONDUCTIVE DUCT (IF)

Other colours available on request

PRODUCT SPECIFICATIONS						
Nominal OD / ID	Class	Length	Colour	Interference Fit (IF)	Packing QTY	
					Meters	Lengths
110 / 102 mm	1	6m	Black	20719	540m	90
160 / 150 mm	1	6m	Black	20323	234m	39
180 / 169 mm	1	6m	Black	20330	168m	28
200 / 188 mm	1	6m	Black	20720	150m	25
225 / 213 mm	1	6m	Black	20721	108m	18
250 / 237 mm	1	6m	Black	20722	96m	16



EF450-022
Scan QR code for
Datasheet

uPVC INTERFERENCE RING SEAL CONDUCTIVE COUPLER (IRS)

Other colours available on request

PRODUCT SPECIFICATIONS						
Nominal OD / ID	Class	Length	Colour	Interference Ring Seal (IRS)	Packing QTY	
					Meters	Lengths
110 / 102 mm	1	6m	Black	20549	540m	90
160 / 150 mm	1	6m	Black	20372	234m	39
180 / 169 mm	1	6m	Black	20717	168m	28
200 / 188 mm	1	6m	Black	20504	150m	25
225 / 213 mm	1	6m	Black	20718	108m	18
250 / 237 mm	1	6m	Black	20401	96m	16



EF450-022
Scan QR code for
Datasheet

HDD ducts conform to Class 1+ ENATS 12-24 and are the ducts of choice for trenchless installations using directional drilling. It's flexibility, strength and fused joints are as strong as the original duct itself, making it ideal for Horizontal Directional Drilling (HDD) applications.

Emtelle have a variety of products that can be installed via HDD. Since high tensile forces (depending on distance and route) are applied during HDD installation, the load requirement for installation needs to be high.



6-12m Lengths
50-100m Coils

SDR11
SDR17



HDD DUCT - SDR11

Other colours and sizes available on request

PRODUCT SPECIFICATIONS			
Nominal OD / ID	Straight Lengths	Coiled Lengths	Colour
75 / 60.7 mm	6m, 12m	50 / 100 / 125 / 150m	Black or Red
90 / 72.9 mm	6m, 12m	50 / 100 / 125 / 150m	Black or Red
110 / 89.2 mm	6m, 12m	50 / 100 / 125 / 150m	Black or Red
125 / 101.4 mm	6m, 12m	50 / 100 / 125 / 150m	Black or Red
140 / 113.6 mm	6m, 12m	50 / 100 / 125m	Black or Red
160 / 129.8 mm	6m, 12m	50 / 100 / 125m	Black or Red
180 / 146.2 mm	6m, 12m	50 / 100m	Black or Red
200 / 162.6 mm	6m, 12m	-	Black or Red
225 / 182.9 mm	6m, 12m	-	Black or Red
250 / 203.5 mm	6m, 12m	-	Black or Red



EF450-052
Scan QR code for
Datasheet

HDD DUCT - SDR17

Other colours and sizes available on request

PRODUCT SPECIFICATIONS			
Nominal OD / ID	Straight Lengths	Coiled Lengths	Colour
75 / 65.4 mm	6m, 12m	50 / 100 / 125 / 150m	Black or Red
90 / 78.6 mm	6m, 12m	50 / 100 / 125 / 150m	Black or Red
110 / 96.1 mm	6m, 12m	50 / 100 / 125 / 150m	Black or Red
125 / 109.5 mm	6m, 12m	50 / 100 / 125 / 150m	Black or Red
140 / 122.6 mm	6m, 12m	50 / 100 / 125m	Black or Red
160 / 140.2 mm	6m, 12m	50 / 100 / 125m	Black or Red
180 / 157.7 mm	6m, 12m	50 / 100m	Black or Red
200 / 175.2 mm	6m, 12m	-	Black or Red
225 / 197.2 mm	6m, 12m	-	Black or Red
250 / 219.4 mm	6m, 12m	-	Black or Red



EF450-052
Scan QR code for
Datasheet

PE Coiled Service Ducts are used within the power market for service cables and specialist applications. The ducts are manufactured to Class 3 Industry standard ENATS 12-24. Standard colours are Black and Red.



Other colours available on request

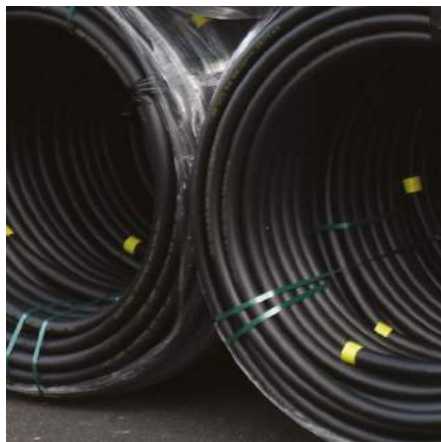

PRODUCT SPECIFICATIONS

Nominal OD / ID	Min bend radius** for handling and lifetime configuration		Individual Coiled Lengths	Coils Per Pack
	Over 5°C	Under 5°C		
37 / 32 mm	0.6m	0.85m	50 / 100m	4
38 / 32 mm	0.53m	0.75m	50 / 100m	4
44 / 38 mm	0.7m	1.0m	50 / 100m	4
50 / 42 mm	0.75m	1.05m	50 / 100m	4
54 / 46 mm	0.8m	0.8m	50m	4
58 / 50 mm	1.0m	1.0m	50m	4
60 / 50 mm	0.7m	1.0m	50m	4
63 / 50 mm	0.7m	1.0m	50m	4

EF450-030
Scan QR code for
Datasheet



Emtelle UK have developed a comprehensive range of Telecom Duct systems and accessories, designed to meet performance requirement for underground Telecom networks. All of our ducts meet industry standard BS EN 61386 450N Class and can be supplied with either an Interference Fit Socket (IP4X) or Interference Ring Seal Socket (IP68).

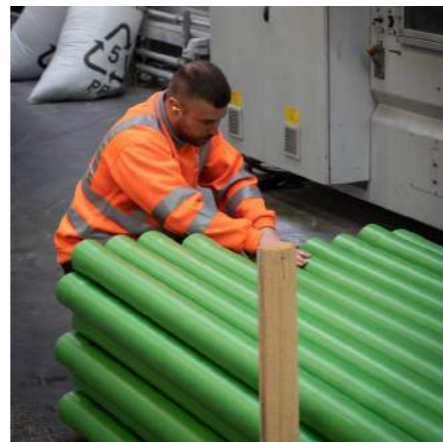

For Telecom Accessories please see page 56 - 61

IP4X
Rated Socket

Interference
Fit (IF)
Socket

450N
Telecom Class

IP68
Rated Socket

Interference
Ring Seal (IRS)
Socket

450N
Telecom Class

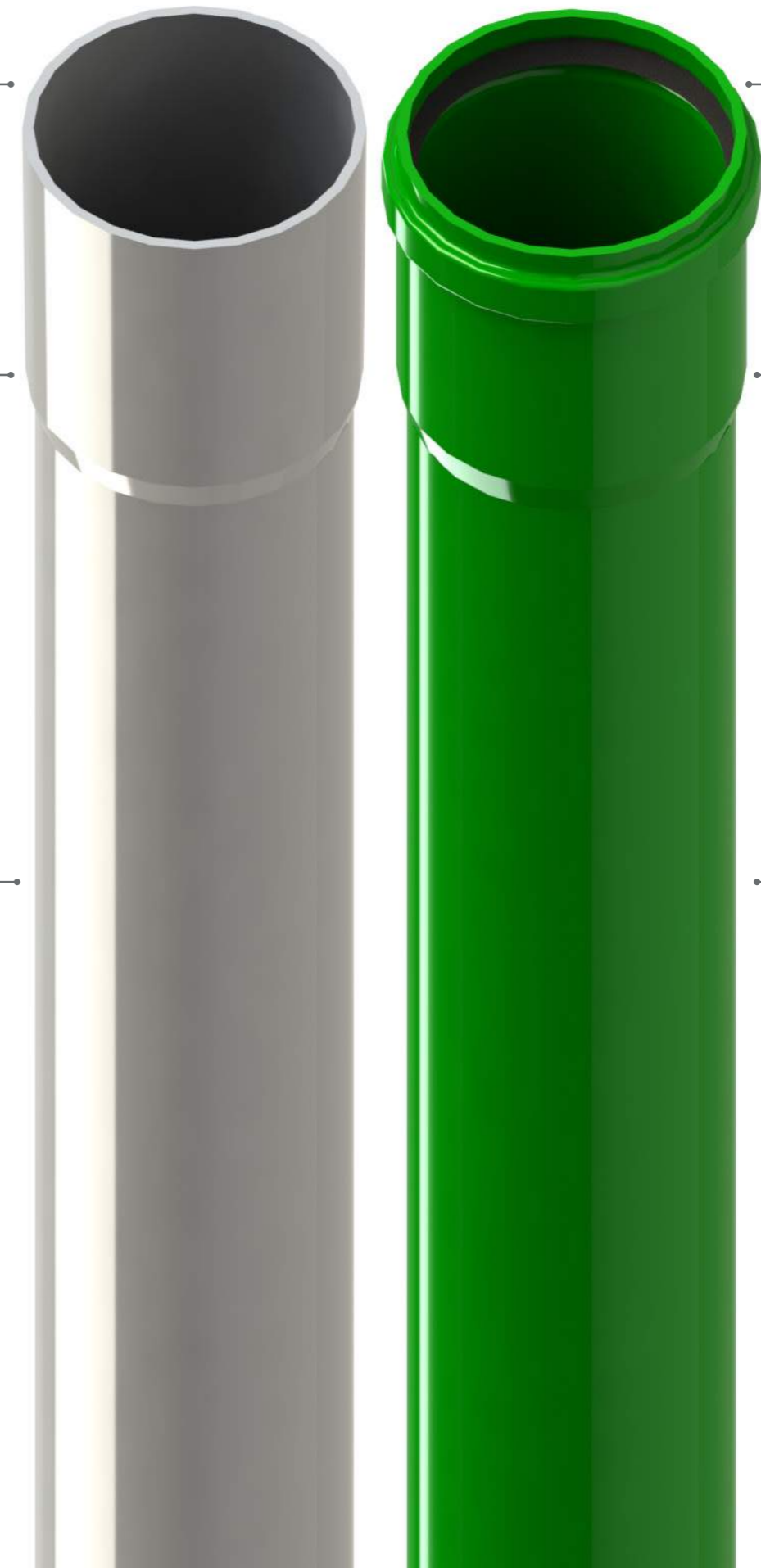

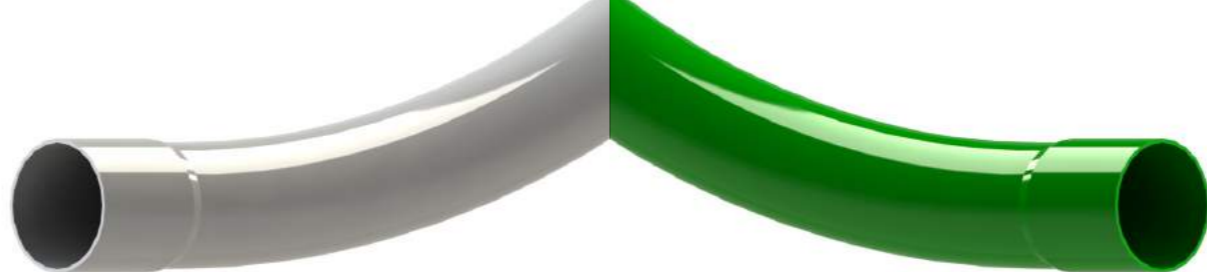

uPVC INTERFERENCE FIT DUCT (IF) IP4X Rated

PRODUCT SPECIFICATIONS							
Nominal OD / ID	Class	Length	Green	Grey	Purple	Packing QTY	
						Meters	Lengths
53.9 / 50 mm	450N	3m	163L	1562	20811	1110m	370
53.9 / 50 mm	450N	4m	21355	21356	✓	1480m	370
53.9 / 50 mm	450N	6m	20425	5636	✓	2220m	370
96.5 / 90 mm	450N	4m	314L	20814	✓	460m	115
96.5 / 90 mm	450N	6m	1879L	857L	20812	690m	115
110 / 103 mm	450N	6m	20246	5701	20293	540m	90
160 / 151 mm	450N	6m	20536	20500	20891	234m	39

uPVC INTERFERENCE RING SEAL DUCT (IRS) IP68 Rated

PRODUCT SPECIFICATIONS							
Nominal OD / ID	Class	Length	Green	Grey	Purple	Packing QTY	
						Meters	Lengths
110 / 103 mm	450N	6m	20362	✓	✓	540m	90
160 / 151 mm	450N	6m	20592	✓	21298	234m	39

✓ available on request



EF450-017
Scan QR code for
Datasheet

uPVC INTERFERENCE FIT BEND (IF) IP4X Rated

Bespoke bends available on request

PRODUCT SPECIFICATIONS				
Nominal OD of Duct	Radius	Angle (deg°)	Colour	Packing QTY
53.9mm	0.15m	45°	Green, Grey, Purple	60 items / bag
	0.2m	90°	Green, Grey, Purple	60 items / bag
	0.35m	11.25°	Green, Grey, Purple	60 items / bag
		22.5°	Green, Grey, Purple	60 items / bag
		45°	Green, Grey, Purple	75 items / bag
96.5mm	0.35m	45°	Green, Grey, Purple	20 items / bag
	0.427m	90°	Green, Grey, Purple	10 items / bag
	0.7m	11.25°	Green, Grey, Purple	20 items / bag
		22.5°	Green, Grey, Purple	20 items / bag
		45°	Green, Grey, Purple	15 items / bag
110mm	0.45m	90°	Green, Grey, Purple	10 items / bag
	0.7m	11.25°	Green, Grey, Purple	20 items / bag
		22.5°	Green, Grey, Purple	20 items / bag
		45°	Green, Grey, Purple	15 items / bag
	160m	0.56m	22.5°	Green, Grey, Purple
45°			Green, Grey, Purple	5 items / bag
90°			Green, Grey, Purple	25 items / timber frame
1.2m		22.5°	Green, Grey, Purple	25 items / timber frame
		45°	Green, Grey, Purple	25 items / timber frame
		90°	Green, Grey, Purple	25 items / timber frame

EF450-011
Scan QR code for
Datasheet



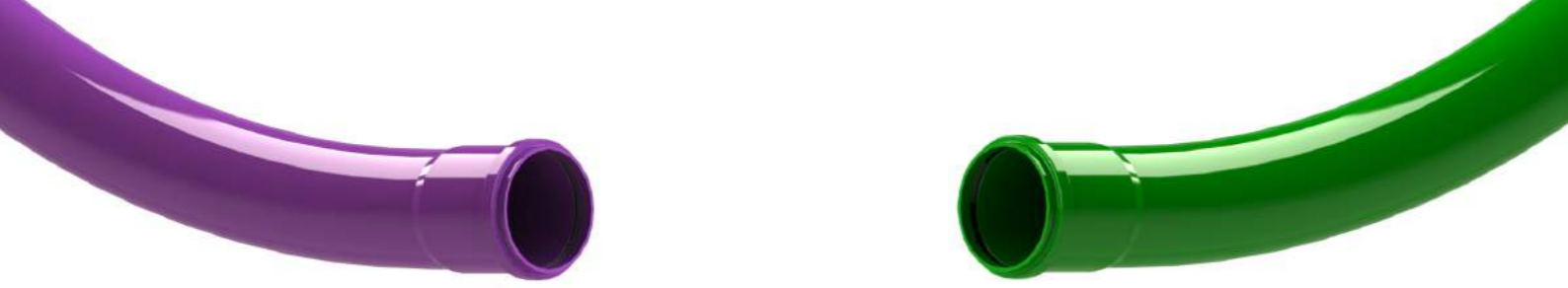

uPVC INTERFERENCE RING SEAL BEND (IRS) IP68 Rated

Bespoke bends available on request

PRODUCT SPECIFICATIONS				
Nominal OD of Duct	Radius	Angle (deg°)	Colour	Packing QTY
110mm	0.7m	11.25°	Green, Grey, Purple	20 items / bag
		22.5°	Green, Grey, Purple	20 items / bag
		45°	Green, Grey, Purple	10 items / bag
		90°	Green, Grey, Purple	10 items / bag
	1.2m	11.25°	Green, Grey, Purple	10 items / bag
		22.5°	Green, Grey, Purple	10 items / bag
		45°	Green, Grey, Purple	50 items / timber frame
		90°	Green, Grey, Purple	50 items / timber frame
160mm	0.56m	45°	Green, Grey, Purple	5 items / bag
		90°	Green, Grey, Purple	25 items / timber frame
	1.2m	11.25°	Green, Grey, Purple	25 items / timber frame
		22.5°	Green, Grey, Purple	25 items / timber frame
		45°	Green, Grey, Purple	25 items / timber frame
		90°	Green, Grey, Purple	25 items / timber frame



EF450-011
Scan QR code for
Datasheet

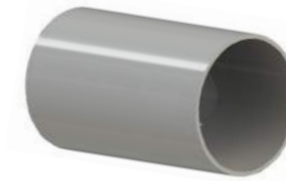

CONNECTOR SLEEVE IP4X Rated DOUBLE SOCKET CONNECTORS IP4X Rated

Other colours available on request

PRODUCT SPECIFICATIONS								
Nominal ID	Length	Connector Sleeve			Double Socket Connectors			Packing QTY
		Green	Grey	Purple	Green	Grey	Purple	
53.9mm	120mm	1258S	804	804P	73905	✓	✓	60 items / bag
96.5mm	200mm	1250S	519	519P	166	✓	✓	60 items / bag
110mm	200mm	3823	20948	20280	3841	✓	✓	50 items / bag
160mm	305mm	21240	✓	✓	✓	✓	✓	15 items / bag

✓ available on request



Connector Sleeve
EF450-009
Scan QR code for
Datasheet

Double Socket Connectors
EF450-006
Scan QR code for
Datasheet



RING SEAL SLIP/STOP COUPLER IP68 Rated

Other colours available on request

PRODUCT SPECIFICATIONS								
Nominal ID	Length	Slip Coupler			Stop Coupler			Packing QTY
		Green	Grey	Purple	Green	Grey	Purple	
110mm	375mm	20910	21039	20914	20911	21040	20915	20 items / bag
160mm	395mm	20919	✓	21303	20849	✓	21289	10 items / bag

✓ available on request

EF450-073
Scan QR code for
Datasheet





SWEPT TEE

PRODUCT SPECIFICATIONS					
Nominal OD of Duct	Swept Branch	Green	Grey	Purple	Packing QTY
53.9mm	53.9mm	76155	76154	76153	25 items / bag
96.5mm	53.9mm	✓	72044	70641	25 items / bag
110mm	53.9mm	71571	✓	72050	25 items / bag

✓ available on request



EF450-004
Scan QR code for
Datasheet



Y-BRANCH

PRODUCT SPECIFICATIONS					
Nominal OD of Duct	Y Branch	Green	Grey	Purple	Packing QTY
53.9mm	53.9mm	2211	✓	✓	50 items / bag
96.5mm	96.5mm	2066	21411	✓	20 items / bag
110mm	110mm	4763	✓	✓	15 items / bag

✓ available on request



EF450-003
Scan QR code for
Datasheet

SPLIT SWEPT TEE

PRODUCT SPECIFICATIONS					
Nominal OD of Duct	Swept Branch	Green	Grey	Purple	Packing QTY
96.5mm	53.9mm	76152	76151	76150	25 items / bag

✓ available on request



EF450-004
Scan QR code for
Datasheet

REDUCER

PRODUCT SPECIFICATIONS						
Nominal OD of Duct 1	Nominal OD of Duct 2	Green	Grey	Purple	White	Packing QTY
96.5mm	53.9mm	550	3189	✓	3895	25 items / bag
110mm	96.5mm	3877	✓	3877P	✓	10 items / bag

✓ available on request



EF450-007
Scan QR code for
Datasheet

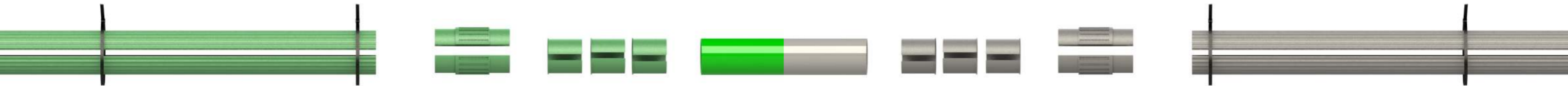

SPLIT DUCT 53.9MM

Other colours available on request

PRODUCT SPECIFICATIONS						
Nominal OD	Length	Green	Grey	Purple	Packing QTY	
					Meters	Lengths
53.9mm	1m	70978	✓	✓	101m	101
	3m	✓	71829	74438	330m	101

SPLIT DUCT 96.5MM & 110MM

Other colours available on request

PRODUCT SPECIFICATIONS						
Nominal OD	Length	Green	Grey	Purple	Packing QTY	
					Meters	Lengths
96.5mm	3m	2393	3286	✓	168m	56
110mm	3m	4507T	4426	74535	126m	42

SPLIT COUPLER 53.9MM

Other colours available on request

PRODUCT SPECIFICATIONS				
Nominal ID	Green	Grey	Purple	Packing QTY
53.9mm	70977	✓	✓	150 items / bag

✓ available on request



EF450-002
Scan QR code for
Datasheet

REPAIR KIT 96.5MM & 110MM

Other colours available on request

PRODUCT SPECIFICATIONS				
Nominal ID	Green	Grey	Purple	Packing QTY
96.5mm	2226	3285	✓	20 items / bag
110mm	4508	4427	74439	20 items / bag

✓ available on request



EF450-002
Scan QR code for
Datasheet

Multipath is a fully developed, proven and integrated cable management system that eliminates the need to winch in sub-duct. All of our Multipath duct meet industry standard BS EN 61386 450N Class. The coupling body is located within the parallel socket of the outer duct and held securely in place by stainless steel barbed clips.

Inner ducts are located and supported inside the outer duct using moulded spacers evenly spaced throughout, and by a full face locking spacer at the spigot end. The coupling body is manufactured with Ring Seals for both inner and outer ducts providing a cable management system which is watertight and airtight.

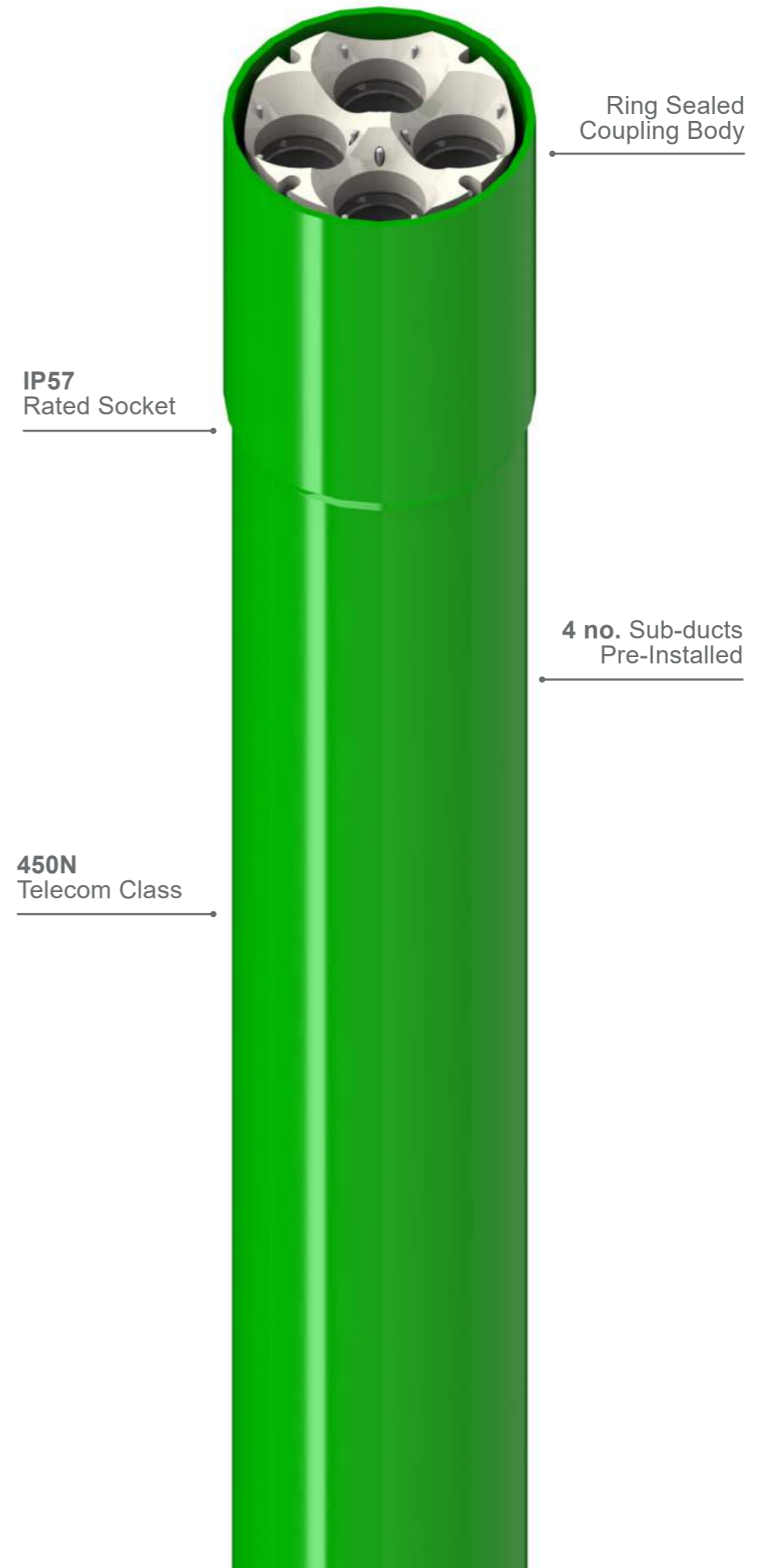
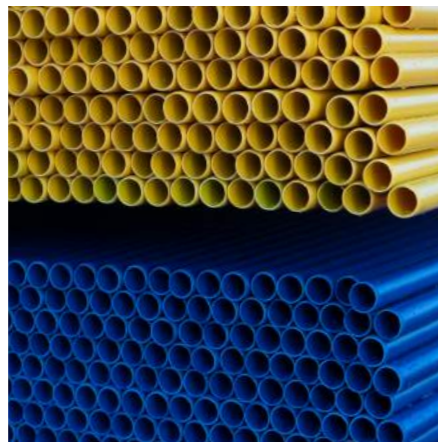
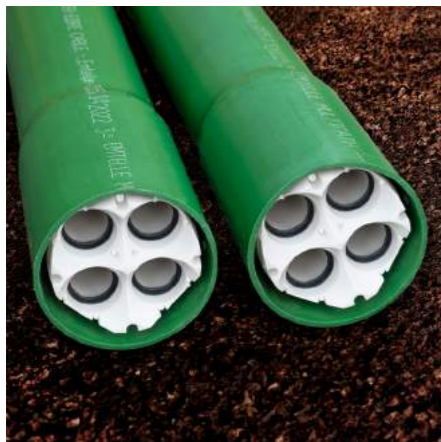



uPVC 4-WAY MULTIPATH DUCT

Other colours available on request

PRODUCT SPECIFICATIONS						
Product Code	Product Description	Length	Primary Duct OD	Inner Duct OD	Packing QTY	
					Meters	Lengths
4330	4-way Green Multipath Duct Black Inner Duct	6.6m	110mm	33mm	330m	50
5939	4-way Green Multipath Duct Red, Yellow, Blue, Grey Inner Duct	6.6m	110mm	33mm	330m	50

uPVC 4-WAY MULTIPATH BENDS

Other colours available on request

PRODUCT SPECIFICATIONS						
Product Code	Product Description	Radius	Angle (deg°)	Nominal OD / ID	uPVC Duct Colour	Packing QTY
20945	4-way Multipath Bend	1.2m	11.25°	110 / 103 mm	Green	6 items / bag
2147	4-way Multipath Bend	3.5m	11.25°	110 / 103 mm	Green	5 items / bag
20946	4-way Multipath Bend	1.2m	22.5°	110 / 103 mm	Green	6 items / bag
2145	4-way Multipath Bend	1.75m	22.5°	110 / 103 mm	Green	5 items / bag
20947	4-way Multipath Bend	1.2m	45°	110 / 103 mm	Green	5 items / bag
20370	4-way Multipath Bend	1.2m	90°	110 / 103 mm	Green	50 items / timber frame
3340	4-way Multipath Flexible Bend	-	-	110 / 103 mm	Green	5 items / bag



EF450-031
Scan QR code for
Datasheet



uPVC 4-WAY MULTIPATH ACCESSORIES

Other colours available on request

PRODUCT SPECIFICATIONS				
Product Code	Product Description	Primary Duct OD	Colour	Packing QTY
2152	Multipath Stop Coupler	117mm	Green	10 items / bag
2154	Multipath Slip Coupler	117mm	Green	10 items / bag
2157	Multipath Type A Terminator	-	White	50 items / bag
2609	Multipath Blowing Gun	-	-	1
9836	Foam Pig for Multipath inner ducts	-	-	10 items / bag
4563	5kn Blue Polyprop Rope (6mm)	-	Blue	500m / Bobbin
3613	Multipath Repair Kit (4xnatural)	-	-	200 items / timber frame



EF450-031
Scan QR code for
Datasheet

Our HDPE Sub-duct systems range from 18mm to 63mm diameter and provide a flexible duct in continuous lengths of up to 3000m (supplied on coils). These solutions allow easy, safe & rapid placement of cabling within main ducting network and can be supplied with an 8kN pull rope pre-installed. As with our ducting solutions, our sub-duct range include a comprehensive range of accessories and ancillary items such as connectors, access chambers, building entry accessories and seals.



Up to
3000m Coils



Bonded **Low Friction** Dry Liner

18 - 63mm
Diameter



Suitable for
Blowing and Pulling Cables



SUB-DUCT

Other colours available on request

PRODUCT SPECIFICATIONS				
Nominal OD / ID	SDR	Nominal Wall Thickness	Max Install Tension	
			kN	kg
18 / 14 mm	9.0	2.0	0.9	90
20 / 14 mm	6.7	3.0	1.4	140
20 / 15 mm	8.0	2.5	1.3	130
20 / 16 mm	10.0	2.0	1.1	110
25 / 20 mm	10.0	2.5	1.7	170
25 / 21 mm	12.5	2.0	1.4	140
28 / 24 mm	14.0	2.0	1.6	160
30 / 26 mm	15.0	2.0	1.5	150
31 / 25 mm	10.3	3.0	2.5	250
32 / 17 mm	4.26	7.5	5.0	500
32 / 20 mm	5.5	5.8	4.8	480
32 / 24 mm	8.0	4.0	3.0	300
32 / 25 mm	9.1	3.5	2.9	290
32 / 26 mm	10.7	3.0	2.6	260
32 / 27 mm	12.8	2.5	2.2	220
32 / 28 mm	16.0	2.0	1.8	180
34 / 28 mm	11.3	3.0	2.7	270
35 / 28 mm	10.0	3.5	3.3	330
35 / 30 mm	14.0	2.5	2.5	250
37 / 29 mm	9.3	4.0	3.3	330
37 / 31 mm	12.3	3.0	3.0	300
37 / 32 mm	14.8	2.5	2.5	250
37 / 33 mm	18.5	2.0	2.0	200
38 / 32 mm	12.7	3.0	3.2	320
40 / 32 mm	10.0	4.0	4.3	430
40 / 33 mm	11.4	3.5	3.7	370
40 / 34 mm	13.3	3.0	3.3	330
40 / 35 mm	16.0	2.5	2.7	270

Other colours available on request

PRODUCT SPECIFICATIONS				
Nominal OD / ID	SDR	Nominal Wall Thickness	Max Install Tension	
			kN	kg
44 / 38 mm	14.7	3.0	3.7	370
50 / 41 mm	10.9	4.6	6.1	610
50 / 42 mm	13.5	3.7	5.4	540
50 / 43 mm	14.3	3.5	4.8	480
60 / 50 mm	12.0	5.0	8.2	820
63 / 50 mm	9.7	6.5	11.0	1100
63 / 52 mm	11.5	5.5	8.9	890

MHT582
Scan QR code for
Datasheet



Emtelle provides the full Power and Telecom ducting solution that includes cable and ducting seals, cable protection, duct cleaning and proving a long with many other accessories and solutions to improve your networks.

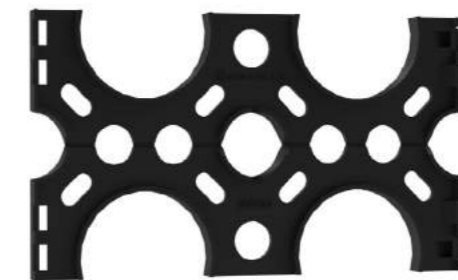
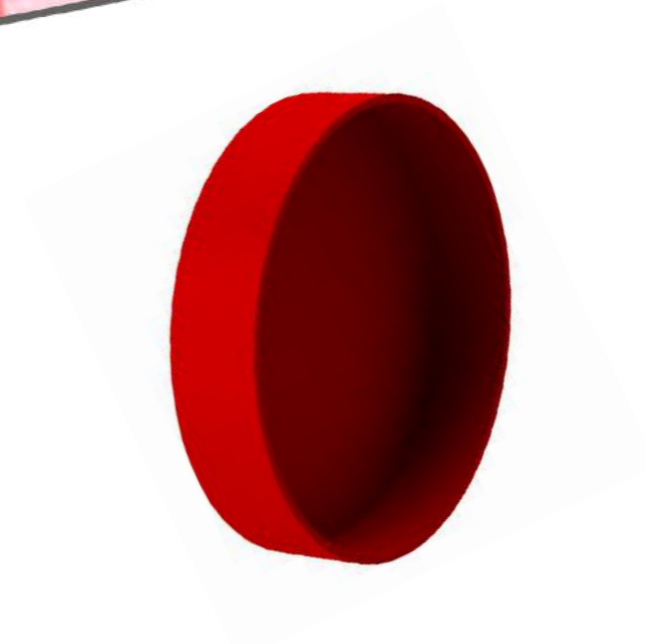

CABLE PROTECTION TILES

Cable protection tiles are heavy duty protective boards designed to provide a protective layer for underground ducted networks.



EF450-051
Scan QR code for
[Datasheet](#)



CABLE PROTECTION TAPE

Provides a protective layer for underground ducted networks. Easy to roll over cable ducts.



EF450-084
Scan QR code for
[Datasheet](#)



CABLE WARNING TAPE

Suitable for power, street lighting and fibre optic cables. Available with detectable wire for traceability.



EF450-070
Scan QR code for
[Datasheet](#)



EXPANSION COUPLERS

The couplers are used in install scenarios to allow for expansion/contraction between two plain ends of two ducts.



EF450-040
Scan QR code for
[Datasheet](#)



TRANSITION COUPLERS

Transition provide the means to connect the plain ends of two ducts with differing internal/external diameters for a smooth transition.



EF450-040
Scan QR code for
[Datasheet](#)



HOCKEY STICK BEND

The Hockey stick bends are used for domestic connections in conjunction with service coils.



EF450-012
Scan QR code for
[Datasheet](#)



END CAP

Provide a means of temporary sealing duct systems during construction to prevent the ingress of dirt and surface water.



EF450-005
Scan QR code for
[Datasheet](#)



KWIKIE BLANK DUCT PLUG

The compressed seal expands into full contact with the inside duct walls thereby providing an effective, seal to your duct system in seconds.



EF450-057
Scan QR code for
[Datasheet](#)



SIMPLEX CABLE SEAL

Simplex Seals consists of a thermoplastic elastomer seal, split to ease cable installation. Inner and outer wedges grasp the pipe or cable creating a rain-proof seal.



EF450-101
Scan QR code for
[Datasheet](#)



ADJUSTABLE DUCT PLUGS

The duct plug can be adjusted to suit the internal diameter of a duct by hand tightening the wing nut.



EF450-058
Scan QR code for
[Datasheet](#)



WALL ENTRY SYSTEMS HSI150/90

The HSI system is casted directly into the wall, for an easy duct and cable entry solution.



EF450-083
Scan QR code for
[Datasheet](#)

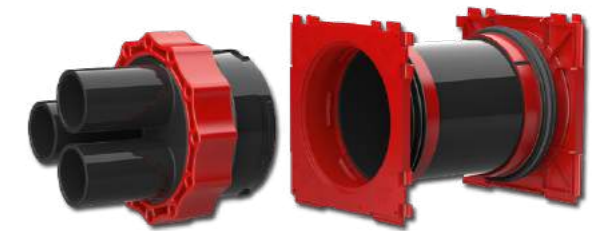

MECHANICAL CABLE & DUCT SEAL

Permanent mechanical duct and cable seals to prevent ingress of dirt and water.



EF450-044
Scan QR code for
[Datasheet](#)



FOAM PIG WITH ROPE

In addition to drawing cable, the foam pig can be used as a pipeline cleaning device.



EF450-063
Scan QR code for
[Datasheet](#)



DUCT BRUSH

Duct brushes are used to removed dirt and debris from inside assembled duct systems.



EF450-066
Scan QR code for
[Datasheet](#)



NYLON PROVING PIG

Nylon proving pigs are used to 'prove' the internal bore of a duct fall below a minimum diameter and has a circular profile.



EF450-067
Scan QR code for
[Datasheet](#)



METAL PROVING PIG

Metal proving pigs are used to 'prove' the internal bore of a duct fall below a minimum diameter and has a circular profile.



EF450-068
Scan QR code for
[Datasheet](#)



DUCT SPACER

Duct spacers are designed to assist when laying duct networks in configurations, e.g. a trefoil or grid array.



EF450-082
Scan QR code for
[Datasheet](#)

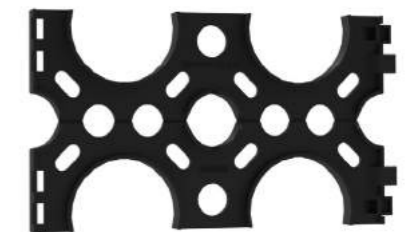

DTS CLIP

DTS clips are designed to clip onto power duct to hold a DTS duct in place.



EF450-100
Scan QR code for
[Datasheet](#)



ACCESS CHAMBER

Designed for both footway and roadway installations where it provides access to underground ducting.



EF450-024
Scan QR code for
[Datasheet](#)



SECURITY INSERT

Provide security and protection of equipment and fibre within telecommunications external chambers.



EF450-042
Scan QR code for
[Datasheet](#)

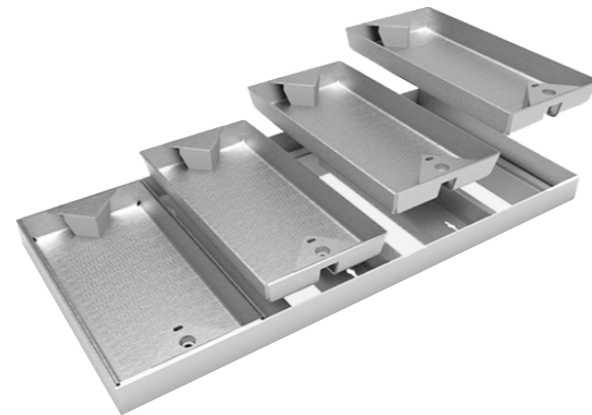

COVERS AND FRAMES

They are suitably designed with manual handling requirements in mind and feature slide out covers with tapered sides for safety.



EF450-046
Scan QR code for
[Datasheet](#)

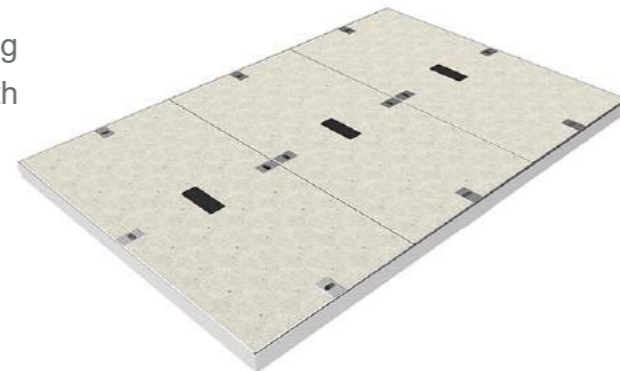

CABLE GUARD

A cable guard is a plastic cable protection capping profile to protect cables on telegraph poles and walls.



EF450-081
Scan QR code for
[Datasheet](#)



CONDUIT WALL FIXING

Conduit wall fixings are used to secure duct to the side of the building.



EF450-085
Scan QR code for
[Datasheet](#)



PULL SOCK

Pull socks are used whenever a cable or other cylindrical objects needs to be pulled inside another duct.



EF450-093
Scan QR code for
[Datasheet](#)



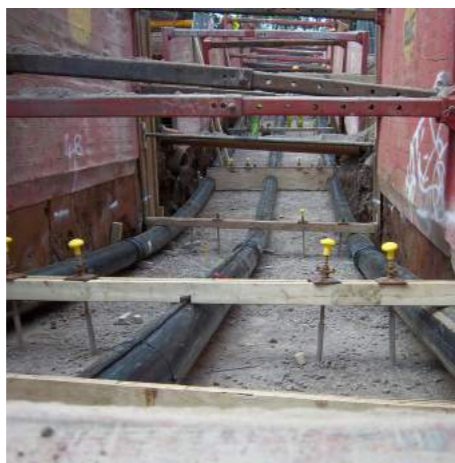
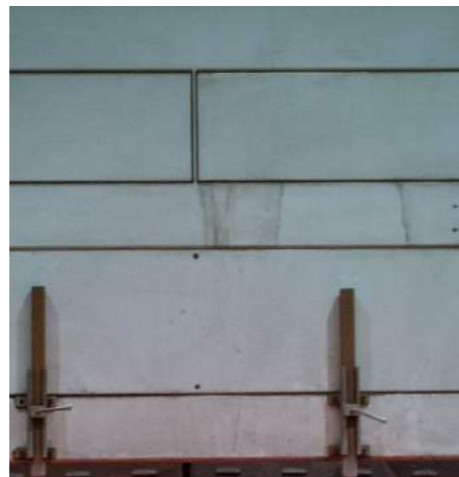



Emtelle UK

Haughhead
Hawick
TD9 8LF
United Kingdom

 +44 (0) 1450 364 000

 info@emtelle.com

Emtelle Scandinavia

Vardevej 140
7280 Sønder Felding
Denmark

 +45 86 28 84 88

 salg@emtelle.com

Emtelle GmbH

An der Flurscheide 20
99098 Erfurt
Germany

 +49 (0) 361 654 330

 info-de@emtelle.com

Emtelle UAE

Plot 597-896
Dubai Investment Park
Dubai, UAE

 +971 4 883 1608

 info@emtelle.com

Emtelle USA

101 Mills Gap Rd
Unit A, Fletcher
NC 28732
USA

 +1 (828) 7079970

 info@emtelle.com

Emtelle Asia Pacific

No. 4, Jalan PJU 1A/8
Taman Perindustrian Jaya
47301 Petaling Jaya
Selangor, Malaysia

 +60 (0)3 7845 4406

 info-my@emtelle.com



EMTELLE.COM